

# PNEUMATIC CONTROL DEVICES

TYPE : SANDWICH

CONTROL DEVICES.TYPE

DPNC#

Sandwich controls with rear ports

## Technical Characteristics

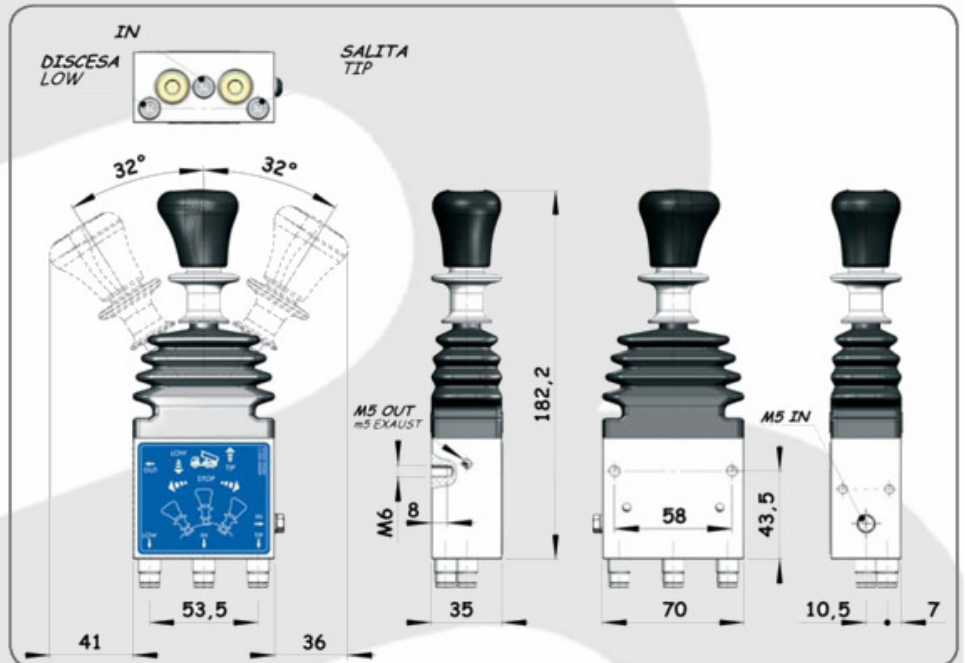

	Versioni disponibili Available versions	Proportional Lowering	Functional Diagram	Pressure		Temperature	
				Min. Bar	Max. Bar	Min. °C	Max. °C
Ritorno cloche Lever return	Automatic Automatic "CE"	DPNC#D00000		5	12	-30	+80
	Manuale Manual (con blocco salita/discesa) (with low and tip block)	DPNC#B00000					

**BINOTTO SRL**

BINOTTO IS CONSTANTLY ENGAGED IN IMPROVING ITS PRODUCTS AND THEREFORE RESERVES THE RIGHT TO MODIFY WITHOUT ANY NOTICE CHARACTERISTICS SHOWN

VIA DIVISIONE JULIA, 7/B - 36031 DUEVILLE [VI] ITALY • TEL. 0039.0444.593290 - FAX. 0039.0444.593357 • E-MAIL. INFO@BINOTTO.COM

Edit.: 04 • 2006

Rev.: 01 • 2006

Date: 01.04.2006

Pag.: DPNC#.001

# PNEUMATIC CONTROL DEVICES

TYPE : SANDWICH

CONTROL DEVICES.TYPE

**DPNC#**

Sandwich controls with rear ports

## Technical Characteristics



**UTILIZZO 1**  
Deliver 1

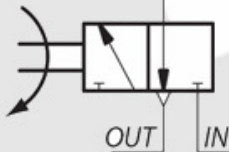

**DPNC#0L0000**

Deviatore pneumatico 2 vie 2 posizioni attacchi inferiori.  
2 way & 2 position pneumatic controls with rear ports

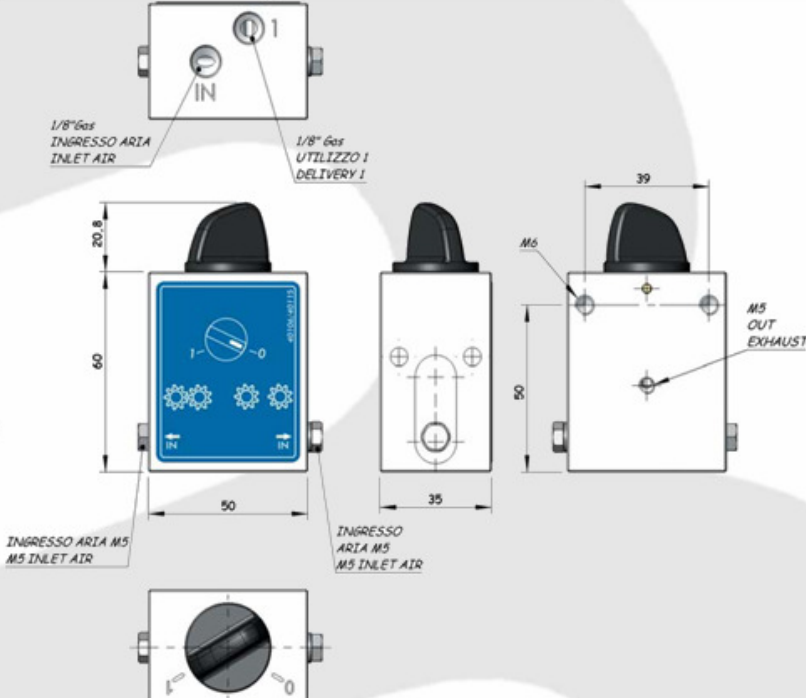

1/8" Gas INGRESSO ARIA INLET AIR

1/8" Gas UTILIZZO 1 DELIVERY 1

20.8

60

50

35

39

M5

M5 OUT EXHAUST

INGRESSO ARIA M5 M5 INLET AIR

INGRESSO ARIA M5 M5 INLET AIR



**UTILIZZO 1**  
Deliver 1

**UTILIZZO y**  
Deliver y

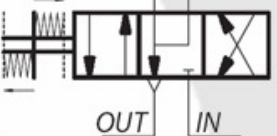

**DPNC#0H0000**

Deviatore pneumatico 3 vie 3 posizioni attacchi inferiori.  
3 way & 3 position pneumatic controls with rear ports

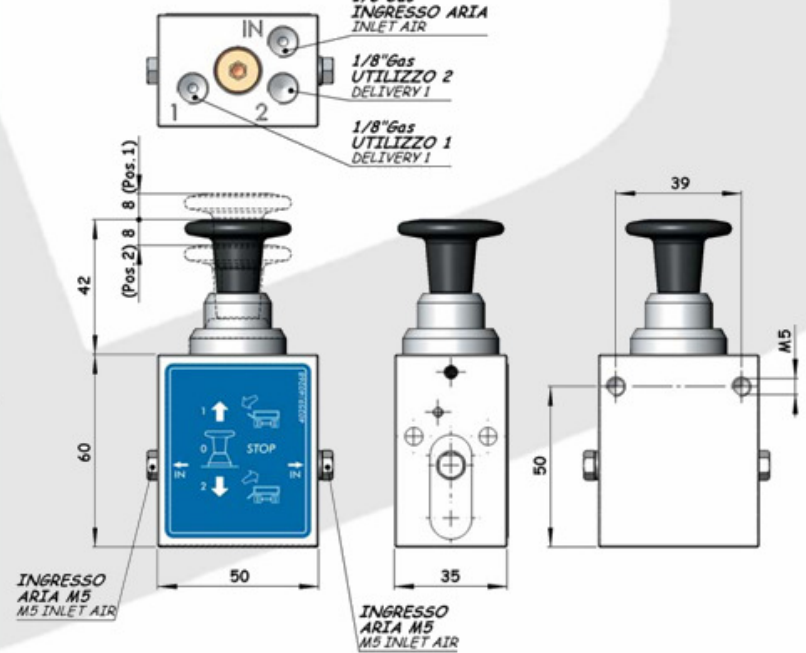

1/8" Gas INGRESSO ARIA INLET AIR

1/8" Gas UTILIZZO 2 DELIVERY 1

1/8" Gas UTILIZZO 1 DELIVERY 1

42

(Pos. 2) 8 & (Pos. 1)

60

50

35

39

M5

INGRESSO ARIA M5 M5 INLET AIR

INGRESSO ARIA M5 M5 INLET AIR

**BINOTTO SRL**

BINOTTO IS CONSTANTLY ENGAGED IN IMPROVING ITS PRODUCTS AND THEREFORE RESERVES THE RIGHT TO MODIFY WITHOUT ANY NOTICE CHARACTERISTICS SHOWN

VIA DIVISIONE JULIA, 7/B - 36031 DUEVILLE [VI] ITALY • TEL. 0039.0444.593290 - FAX. 0039.0444.593357 • E-MAIL. INFO@BINOTTO.COM

Edit.: 04 • 2006

Rev.: 01 • 2006

Date: 01.04.2006

Pag.: DPNC#.002